

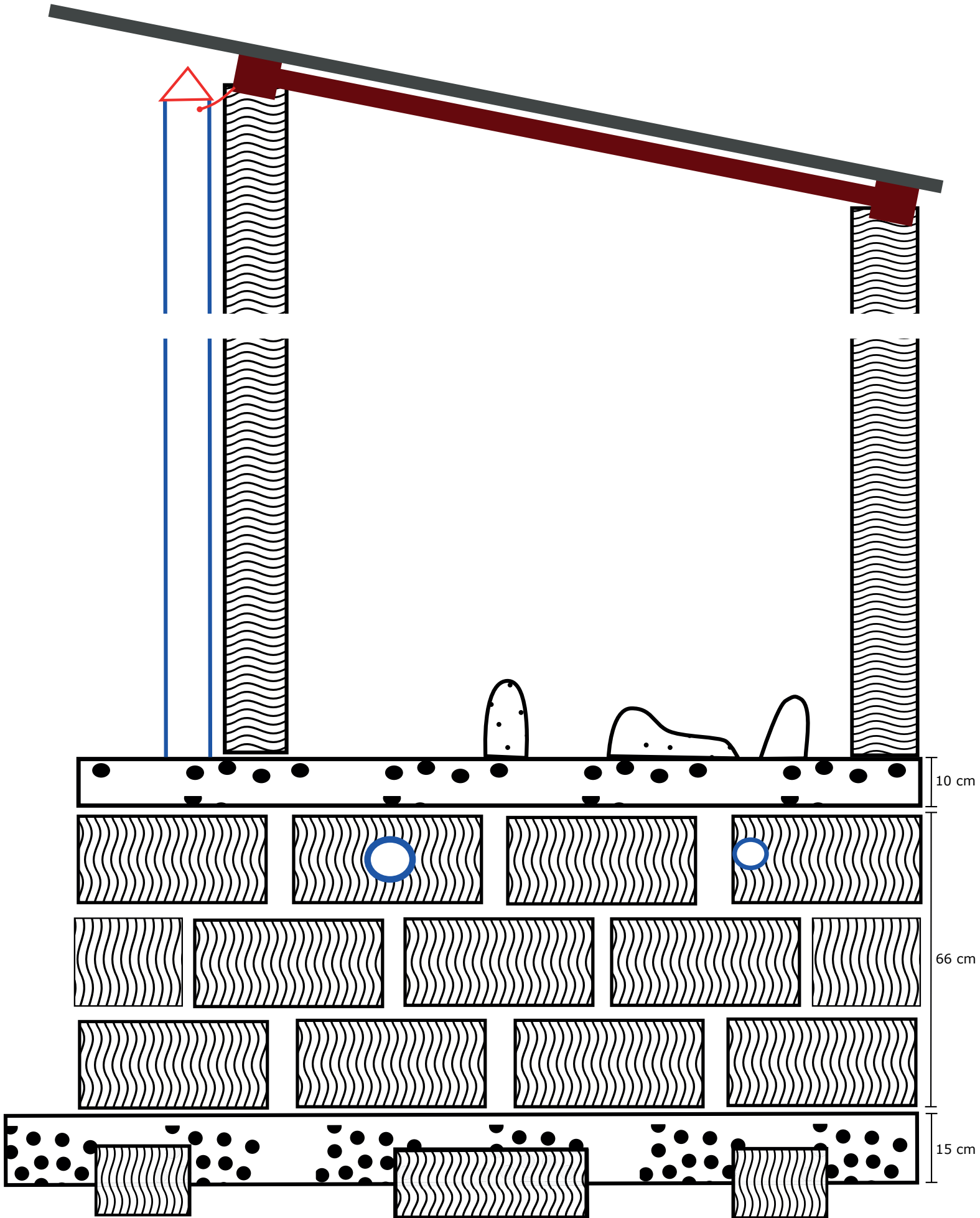

PLANS DE LA LATRINE BANTOU

Coupe gauche

Echelle 1:10



Dimension des dalles à séparation

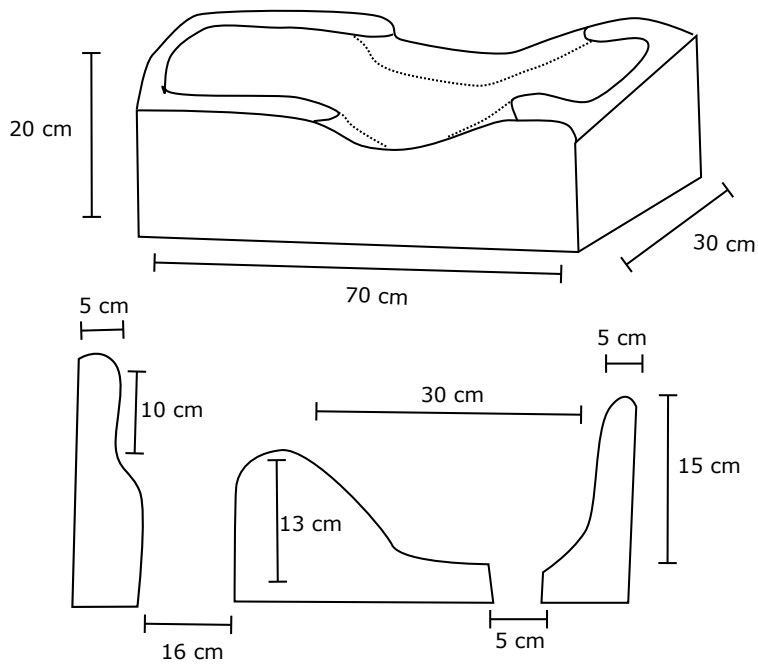

Fondations

Echelle 1:10

200 cm

225 cm

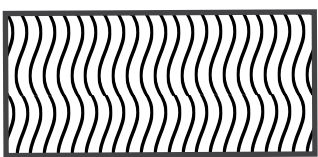
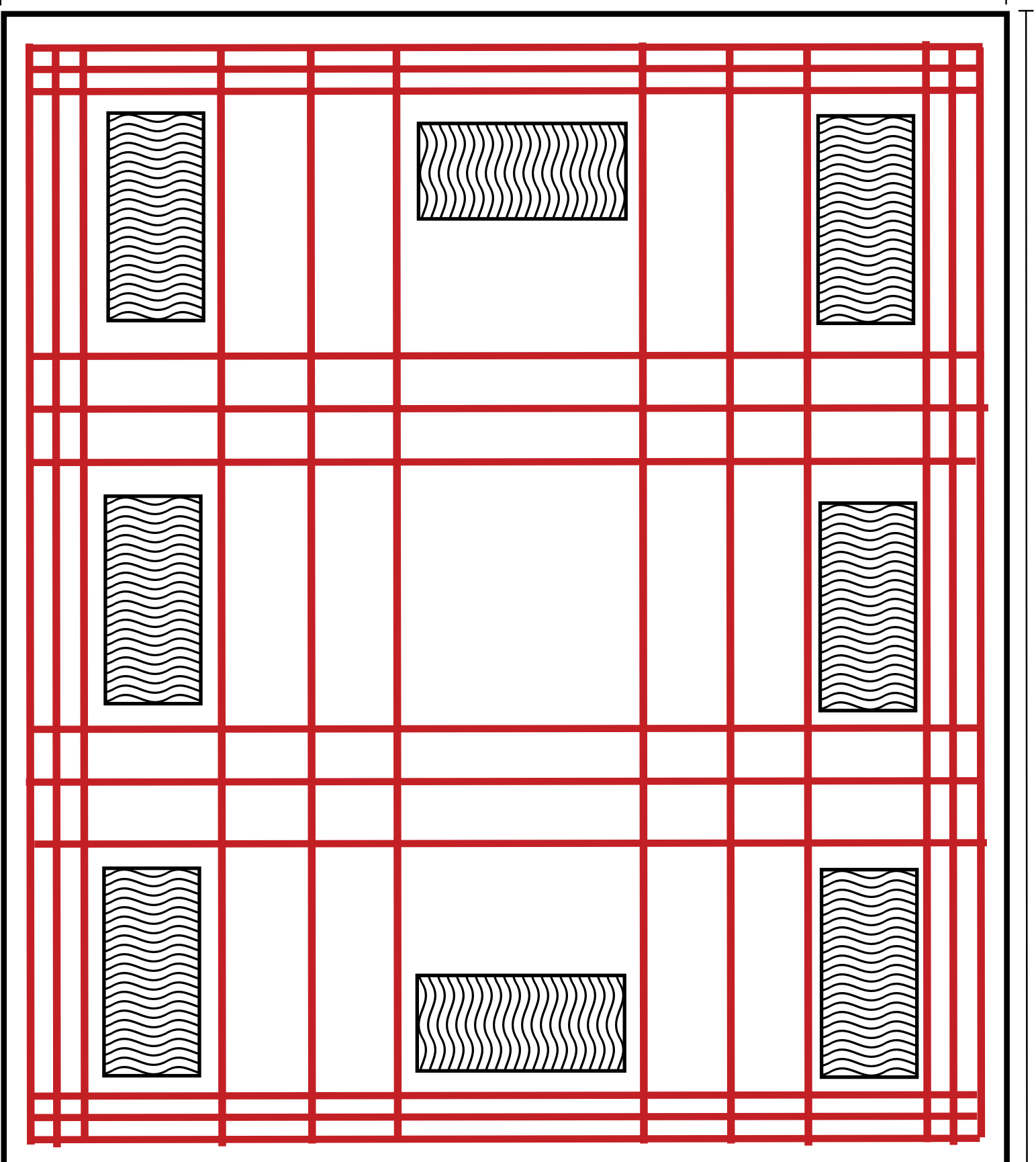

Briques



Treillis

Fosses

Echelle 1:10

225 cm

185 cm

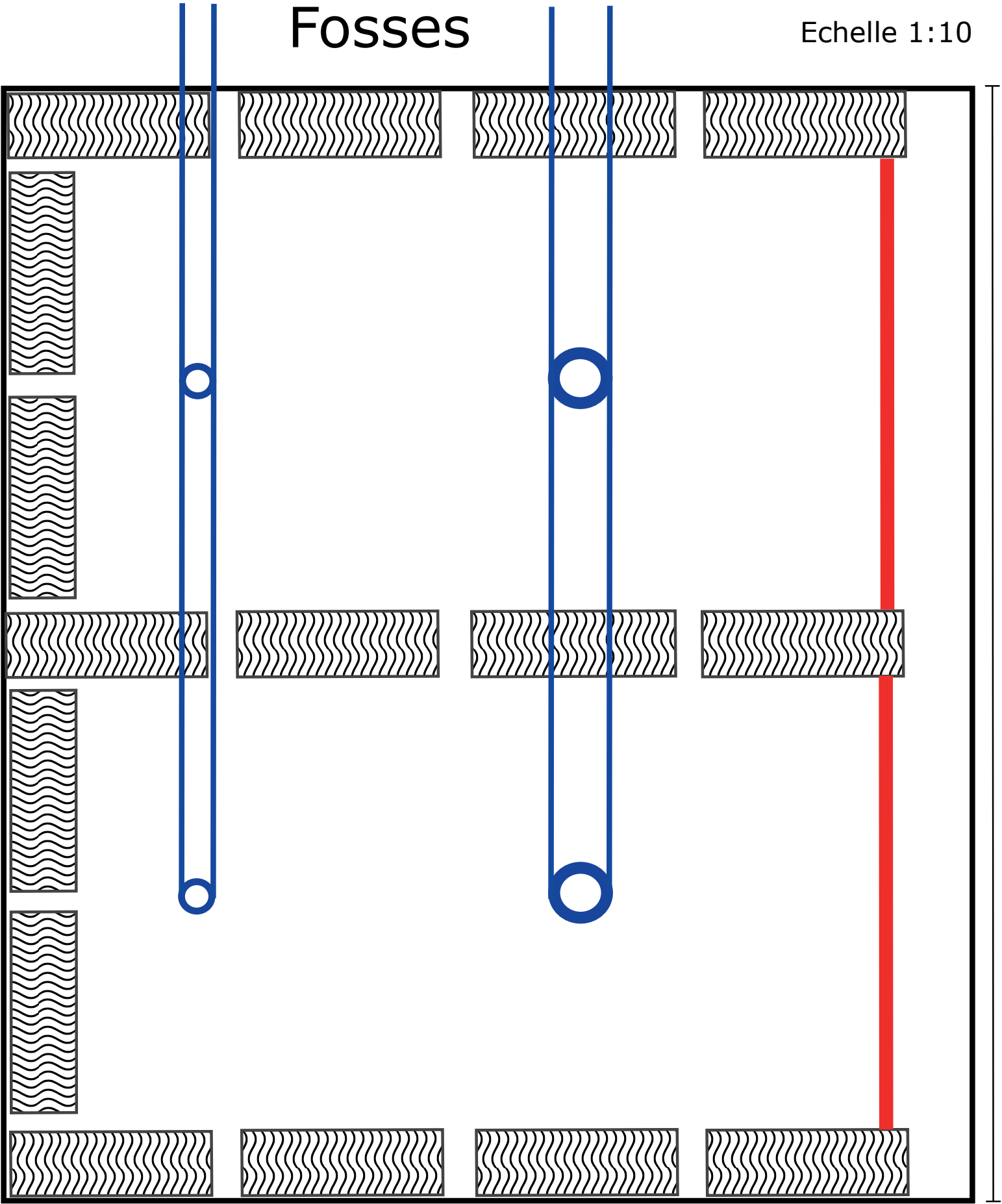

Briques



Tuyauterie



Portes

Dalle de recouvrement

Echelle 1:10

185 cm

225 cm

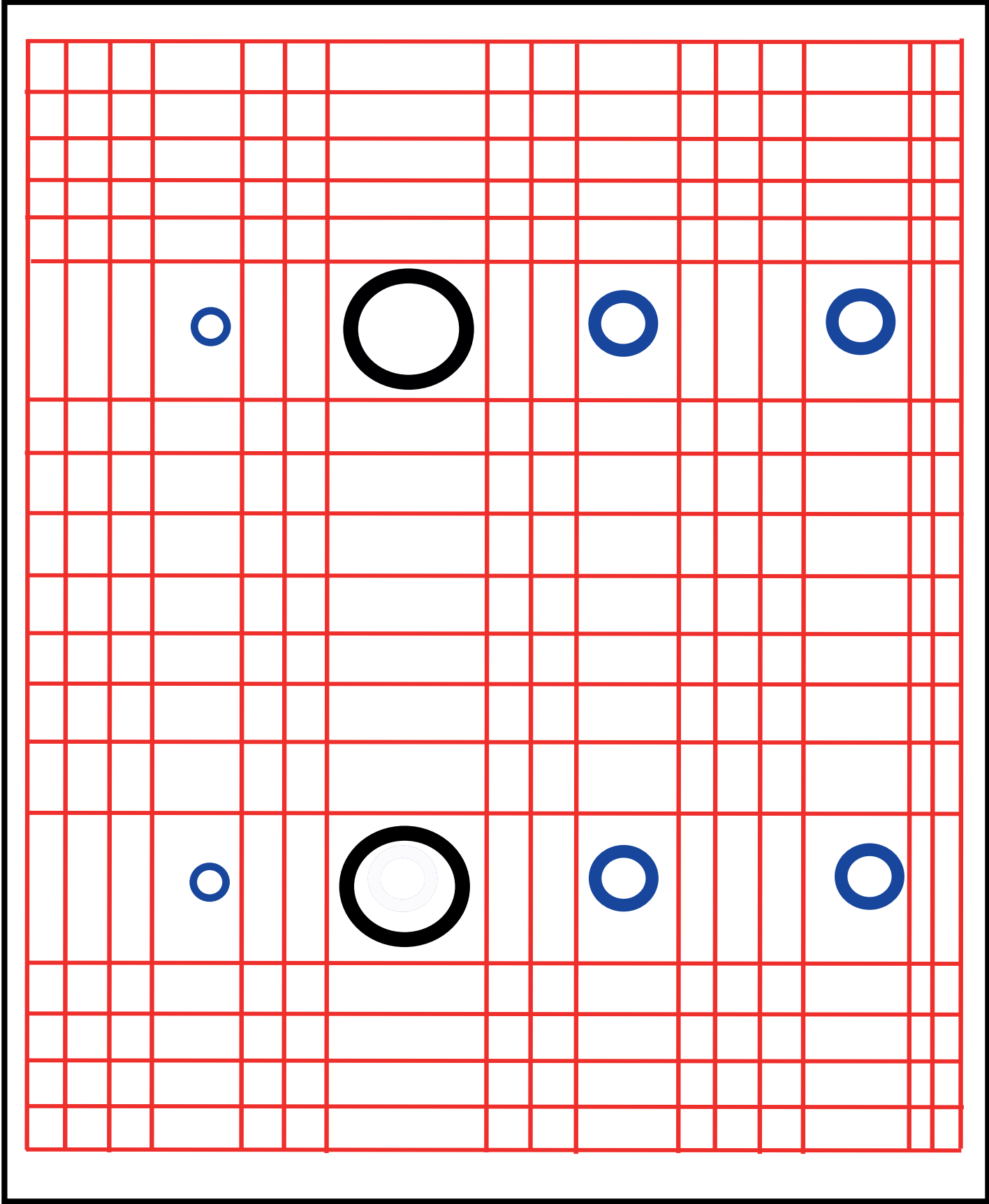

Briques



Treillis



Emplacement des trous pour la tuyauterie

Intérieur

Echelle 1:10

185 cm

225 cm

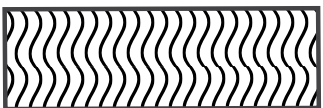
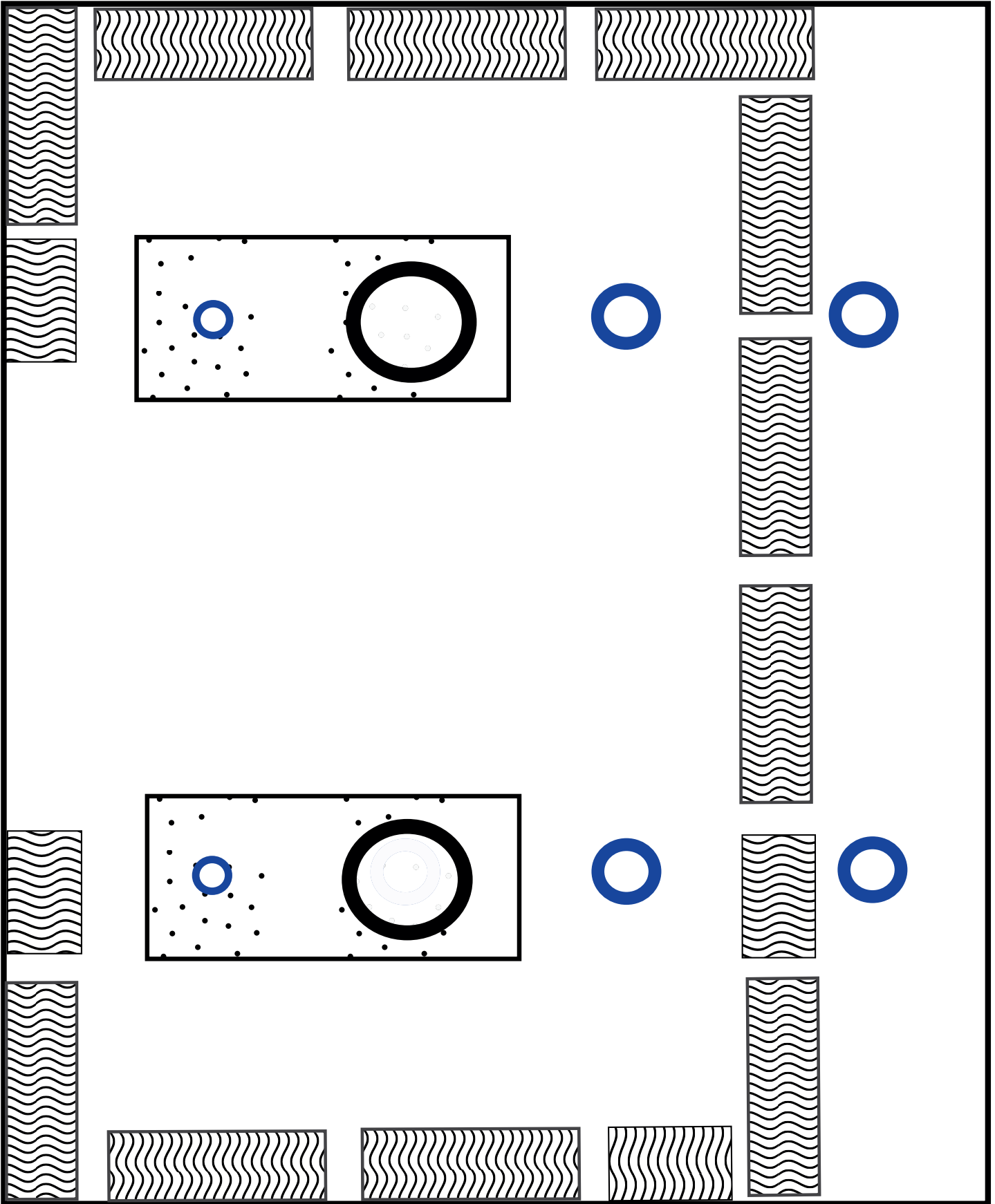

Briques



Tuyauterie

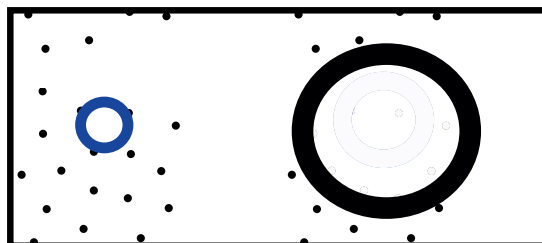

Dalles à
séparation
d'urine